



CENTRALVETERINARIA.COM.BR

CATÁLOGO  
2022



LINHA ANIMAIS DE COMPANHIA

- ☎ (34) 3211-0500
- 📷 @CENTRAIVETUDIA
- ✉ SAC@CENTRALVETERINARIA.COM.BR
- 📍 RUA IGNEZ FAVATO, 302 - BAIRRO DISTRITO INDUSTRIAL  
UBERLÂNDIA-MG | CEP:38402-340

Entregamos para  
todo Brasil





# ÍNDICE

BIASOLI	03	LEMA	10
BIMEDA	03	MATACURA	10
BIOFARM	03	MSD	11
BRAVET	04	NATURRICH	11
CALBOS	05	NOXON	12
CHEMITEC	05	ORGANNACT	12
CIRÚRG.E DESC	16	ORIENTE	12
CITROMAX	18	PINUS	12
COVELI	05	PRADO	12
DECHRA	06	SERVER	23
DIPIL	21	SIMÕES	13
FABIANI	07	SM	13
HIPRA	07	SYNTEC	14
IBASA	07	UCBVET	14
INDUBRAS	07	VANSIL	14
JOFADEL	08	VETBRÁS	14
KELLDRIN	21	VILAVET	03
KOMBATE	23	WORLD	16
LABGARD	08	ZOETIS	16
LAVIZOO	08		







VILAVET



Cód. 6882  
CEVIT 30ML - VILAVET



Cód. 8100  
HEMOVET PET 30ML - VILAVET



Cód. 8092  
SUPLENATE 250G - VILAVET



Cód. 8093  
VERMICOL 30ML - VILAVET



BIASOLI



Cód. 6024  
LEITE MAMALAC PET CAES E GATOS 250G - BIASOLI



BIMEDA



Cód. 2657  
PRAZIFEN CAES E GATOS - BIMEDA



BIOFARM



Cód. 644  
BABECID CAES 10ML - BIOFARM



Cód. 5102  
BIOTHION CAES 100 CP - BIOFARM



Cód. 5142  
BIOTOX PET PULV 20ML - BIOFARM



Cód. 4291  
BIOTRIL - BIOFARM



Cód. 2765  
CALCIOFARM MIX PET 125ML - BIOFARM



Cód. 643  
CARBOVET 20 CP - BIOFARM



Cód. 4322  
CARRAPATOX PET - PULV. 20ML - BIOFARM



Cód. 4274  
COLIRIO BIOFARM 20ML - BIOFARM



Cód. 642  
COLIRIO PET BIOFARM 20ML - BIOFARM



Cód. 1390  
CORTISOL PET 20CP - BIOFARM



**Cód. 6885**  
DERMOTAN PET 100ML -  
BIOFARM



**Cód. 5228**  
ESTROGIN INJ 2ML -  
BIOFARM



**Cód. 5172-5173**  
FLOXICLIN 50MG - 150MG  
10CP - BIOFARM



**Cód. 4271**  
FLUIDO BIOFARM 100ML -  
BIOFARM



**Cód. 4294-4293-4296**  
GLICOFARM PET 30ML -  
60ML- 125ML - BIOFARM



**Cód. 4297-4298**  
HEMOfarm PET 30 - 60  
ML - BIOFARM



**Cód. 4308**  
HEPAVET INJ 10ML -  
BIOFARM



**Cód. 4410**  
IVERMECTINA  
BIOMECTINA DISPLAY  
50X1,0ML - BIOFARM



**Cód. 4266**  
LIDOFarm INJ 50ML -  
BIOFARM



**Cód. 5043**  
OTOVET LIMP 100ML -  
BIOFARM



**Cód. 5044**  
OTOVET SOLUCAO 20ML -  
BIOFARM



**Cód. 3327**  
SARNIRAN PET 30ML -  
BIOFARM



**Cód. 6443**  
SPOT PLUS 1,5 ML ATÉ  
10KG - BIOFARM



**Cód. 6445**  
SPOT PLUS 6,0 ML DE 20  
A 40KG - BIOFARM



**Cód. 1959**  
SPOT PLUS 9,0 ML ACIMA  
DE 40KG - BIOFARM



**Cód. 6444**  
SPOT PLUS 3,0 ML DE 10 A  
20KG - BIOFARM



**Cód. 1391**  
TUSSEDAN XAROPE  
100ML - BIOFARM



**Cód. 4312**  
VETIOLATE 30ML -  
BIOFARM



BRAVET



**Cód. 550**  
MERCePTON ORAL 20ML -  
BRAVET





**Cód. 3471**  
**OTODERMIN 20ML - BRAVET**



**Cód. 4771**  
**SULFAPRIM 10CP - BRAVET**



**CALBOS**



**Cód. 6210**  
**ANTEC 4CP - CALBOS**



**CHEMITEC**



**Cód. 763**  
**CHEMITAL CAES 4CP - CHEMITEC**



**Cód. 953**  
**CHEMITAL GATOS 4CP - CHEMITEC**



**Cód. 762**  
**CHEMITAL PLUS 4CP - CHEMITEC**



**Cód. 1821**  
**CHEMITAL PUPPY ORAL 20ML - CHEMITEC**



**Cód. 3504**  
**CHEMITRIL 150MG 10CP - CHEMITEC**



**Cód. 3468**  
**CHEMITRIL 50MG 10CP - CHEMITEC**



**Cód. 3271**  
**DEXIUM 5MG - CHEMITEC**



**Cód. 4816**  
**EC-PET 1,34ML - CHEMITEC**



**Cód. 4817**  
**EC-PET 2,68ML - CHEMITEC**



**Cód. 4818**  
**EC-PET 4,02ML - CHEMITEC**



**Cód. 4815**  
**EC-PET 67ML - CHEMITEC**



**Cód. 7223**  
**ELO-XICAM 0,2% INJ. 20ML - CHEMITEC**



**Cód. 7221**  
**ELO-XICAM 0,5MG - CHEMITEC**



**Cód. 7222**  
**ELO-XICAM 2,0MG - CHEMITEC**



**COVELI - PET**



**Cód. 4497**  
**AVITRIN AMINOACIDOS**  
15ML - COVELI - PET



**Cód. 2453**  
**AVITRIN ANTIBIOTICO**  
10ML - COVELI - PET



**Cód. 2450**  
**AVITRIN CALCIO PLUS**  
15ML - COVELI - PET



**Cód. 2435**  
**AVITRIN E 15ML -**  
COVELI - PET



**Cód. 2452**  
**AVITRIN FERRO MAX 15**  
ML - COVELI - PET



**Cód. 2436**  
**AVITRIN MUDA 15 ML -**  
COVELI - PET



**Cód. 2448**  
**AVITRIN PLUMAS 15 ML -**  
COVELI - PET



**Cód. 2455**  
**AVITRIN POLIVITAMINICO**  
15 ML - COVELI - PET

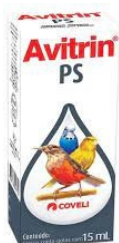

**Cód. 4965**  
**AVITRIN PS 15 ML -**  
COVELI - PET



**Cód. 933**  
**AVITRIN REPRODUÇÃO 15**  
ML - COVELI - PET



**Cód. 2447**  
**AVITRIN SULFA 10ML -**  
COVELI - PET



**Cód. 2437**  
**AVITRIN VERMIFUGO 10**  
ML - COVELI - PET



**Cód. 2430**  
**COLEIRA VAPONEX 20GR -**  
COVELI - PET



**Cód. 2449**  
**TETISARNOL 150 ML**  
AEROSOL - COVELI - PET



DECHRA



**Cód. 4235**  
**ACEPROVEN GOTAS**  
30ML - DECHRA



**Cód. 3905**  
**SORO GASTROGLOBULIN**  
10ML - DECHRA



**Cód. 2612**  
**SORO GLOBULIN CANNIS**  
POLIVALENTE 5ML -  
DECHRA



**Cód. 4048**  
**SORO SOROGLOBULIN**  
10ML - DECHRA



**Cód. 6575**  
**SORO SOROGLOBULIN**  
MAX 10ML - DECHRA





**Cód. 3629**  
**VAC RAIVA BIORAIVA PET**  
**C/12 - DECHRA**

**FABIANI**

**Cód. 4431**  
**VITAGOLD ORAL**  
**POTENCIADO 20ML -**  
**FABIANI**

**HIPRA**



**Cód. 2919**  
**HIPRALONA ENRO S**  
**GOTAS 10ML - HIPRA**

*A vida exige o melhor.*

**Cód. 1361**  
**CETOCONAZOL SHAMPOO**  
**2,0% 100ML - IBASA**

**Cód. 1368**  
**CETOCONAZOL**  
**SUSPENSÃO ORAL 20%**  
**20ML - IBASA**



**Cód. 1372**  
**IBATRIM ORAL CAES E**  
**GATOS 20ML - IBASA**

**Cód. 7606**  
**IBATRIM ORAL CAES E**  
**GATOS 50ML - IBASA**

**Cód. 7703**  
**OUIPET**  
**DERMOCALMANTE IBASA**  
**30ML - IBASA**

**Cód. 1370**  
**SABONETE ANTIPULGAS**  
**IBAPET 80G - IBASA**



**Cód. 640**  
**SPRAY ANTIPULGAS E**  
**CARRAP IBASA 100ML -**  
**IBASA**

**Cód. 1371**  
**TALCO ANTIPULGAS**  
**IBASA 100G - IBASA**

**INDUBRAS**

**Cód. 6266**  
**AMITRAZ PET INDUBRAS**  
**20ML - INDUBRAS**



**Cód. 139-140**  
**AVEMIL SOLUCAO 20ML -**  
**100ML - INDUBRAS**

**Cód. 115**  
**CEVAVITA 200G -**  
**INDUBRAS**

**Cód. 6587**  
**FARINHA DE CALCIO**  
**INDUBRAS 1,0KG -**  
**INDUBRAS**

**Cód. 6268**  
**LINOPLUS 180ML -**  
**INDUBRAS**



**Cód. 1058**  
MATA BICHEIRA  
INDUBRAS PRATA  
200ML - INDUBRAS



**Cód. 3616**  
STRONDAL 4CP -  
INDUBRAS



**Cód. 1066**  
STRONDAL PLUS 4CP -  
INDUBRAS



**Cód. 143-144**  
THUYA TINTURA 20ML -  
90ML - INDUBRAS



**Cód. 3614**  
VERMEX PLUS ORAL  
20ML - INDUBRAS



**Cód. 3615**  
VERMEX SOLUCAO ORAL  
20ML - INDUBRAS



**Cód. 114**  
VERMITRAT P CAES-  
GATOS 150COMP -  
INDUBRAS



JOFADEL



**Cód. 3077**  
DOLEMIL BISNAGA 10G -  
JOFADEL



**Cód. 2033**  
PENAVIAR PO 30G -  
JOFADEL



LABGARD



**Cód. 7024**  
DEXAGARD 20CP -  
LABGARD



**Cód. 7388**  
ENROGARD 50MG -  
LABGARD



LAVIZOO



**Cód. 1990-1976**  
AMINOPAN PET 100G -  
500GR - LAVIZOO



**Cód. 4877**  
AMINOSOL PASSAROS  
10ML - LAVIZOO



**Cód. 1996**  
AMINOSOL PET 1,0L -  
LAVIZOO



**Cód. 2067**  
ANTI TARTARO LAVIZOO  
100GR - LAVIZOO



**Cód. 4936**  
AURICUR LIMP 100ML -  
LAVIZOO



**Cód. 1973-1974**  
FORTFLEX PET 30 COMP-  
60 COMP. - LAVIZOO



**Cód. 1414**  
GEL AURICULAR 11,5 GR  
VETANCO - LAVIZOO



**Cód. 2695**  
GELOVET GEL 300G -  
LAVIZOO



**Cód. 5356**  
GELOVET SPRAY 100ML -  
LAVIZOO



**Cód. 1979-1995**  
GLICOSOL PET 200ML - 50  
ML - LAVIZOO



**Cód. 867**  
HEPGEL PET 50GR -  
LAVIZOO



**Cód. 3301**  
LAVIZ MO PET 30GR -  
LAVIZOO



**Cód. 4860**  
LAVIZOO ANTIBIOTICO  
50GR LAVIMED SD -  
LAVIZOO



**Cód. 2865**  
LAVIZOO CALCIO 15ML -  
LAVIZOO



**Cód. 1969**  
LAVIZOO LIMPA  
LAGRIMAS 100ML -  
LAVIZOO



**Cód. 2866**  
LAVIZOO MUDA 15ML -  
LAVIZOO



**Cód. 2874**  
LAVIZOO  
REPRODUCAO/CANTO  
15ML - LAVIZOO



**Cód. 4888**  
OROSOL PASSAROS  
10ML - LAVIZOO



**Cód. 854**  
PROGARD F 5G - LAVIZOO



**Cód. 619**  
PROGARD PLUS 50 5G -  
LAVIZOO



**Cód. 2787-2694**  
SHAMPOO CETODINE  
125ML - 240ML - LAVIZOO



**Cód. 4357**  
SUPLECAL PET 200 GR -  
LAVIZOO



**Cód. 1975**  
SUPRAFER PET 30G -  
LAVIZOO



**Cód. 1795**  
SUPRAFER PET 50ML -  
LAVIZOO



**Cód. 4894**  
SUPRESSOR DE CIO 12CP -  
LAVIZOO



**Cód. 4806**  
VERMICAO 04CP -  
LAVIZOO





LEMA

**Cód. 3511**  
COLEIRA TRATTO 17G -  
LEMA

**Cód. 3025**  
INIBIDEX CARTELA 5  
UNID - LEMA

**Cód. 1921**  
INIBIDEX INJ 1ML - LEMA



**Cód. 2742**  
SABONETE SARNATYL  
100GR - LEMA

**Cód. 685**  
SORO CINO-GLOBULIN  
10ML GELADO AZUL -  
LEMA

**Cód. 684**  
SORO ENTERO-GLOBULIN  
10ML GELADO ROSA -  
LEMA

**Cód. 3152**  
TRIDOXIN 40 PASTA ORAL  
10ML - LEMA



**Cód. 6931**  
VAC BIO MAX BASICA (V8)  
2ML - LEMA

**Cód. 6935**  
VAC POLY 10 BASICA  
(V10) 2ML - LEMA

**Cód. 6937**  
VAC POLY 10 RASG APLIK  
(V10) 2ML - LEMA

**Cód. 6942**  
VAC RAIVA I CAES GATOS  
BASICA 1DS - LEMA



**Cód. 6938**  
VAC TRI BABY BASICA  
1,0ML - LEMA

**Cód. 3083**  
VERMOTRIX PLUS 04CP -  
LEMA

**Cód. 1586**  
VETOL INJ 2,0ML - LEMA

**Cód. 1587**  
VETOL SOLUCAO ORAL  
20ML - LEMA



MATACURA

**Cód. 694**  
POMADA CICATRIZANTE  
SARALOGO 30G -  
MATACURA

**Cód. 3268**  
SABONETE ANTISSEPTICO  
90G - MATACURA

**Cód. 3267**  
SABONETE SARNICIDA  
80G - MATACURA





**Cód. 2869**  
SHAMPOO ANTISSEPTICO  
HORSE 1,0L - MATACURA



**Cód. 3269**  
SHAMPOO SARNICIDA  
200ML - MATACURA



MSD



**Cód. 995**  
AZIUM SOLUCAO INJ  
10ML - MSD



**Cód. 4686**  
BANAMINE 10ML - MSD



**Cód. 1016**  
BIOXAN COMPOSTO  
500ML - MSD



**Cód. 283**  
BORGAL INJ 10ML - MSD



**Cód. 2079**  
BUTOX PULV. 20ML - MSD



**Cód. 1035**  
CALMINEX 30G - MSD



**Cód. 2402**  
DIAZEN INJ 15ML - MSD



**Cód. 1954**  
DORCIPEC INJ 10ML - MSD



**Cód. 3493**  
GLUCAFOS 200ML - MSD



**Cód. 2950**  
HEPATOXAN 100ML - MSD



**Cód. 1106**  
IMIZOL INJ 15ML - MSD



**Cód. 2575**  
POTENTY PULV. 300ML -  
MSD



**Cód. 6190**  
REVERIN PLUS LA 50ML -  
MSD



**Cód. 5445**  
SEPTIPEN PLUS 15ML  
DISPLAY - MSD



**Cód. 1253**  
TRIA TOX PULV 200ML -  
MSD



**Cód. 2748**  
ZALIX INJ 10ML - MSD



NATURRICH



**Cód. 2626**  
MEBENDAZOLE  
CAES/GATOS - NATURRICH



**Cód. 780**  
NATU VERM COMP CAES  
E GATOS - NATURRICH



**Cód. 429**  
NATU VERM SUSPENSÃO  
20ML - NATURRICH



**Cód. 786**  
NATUFLIN CX 10 COMP -  
NATURRICH



**Cód. 3030**  
PIPI NATU DOG 20ML -  
NATURRICH



**Cód. 778-783**  
THUYA AVICOLA  
NATURRICH 30ML -  
100ML - NATURRICH



NOXON



**Cód. 2980**  
PROBIOTICO PET NOXON  
14GR. - NOXON



**Cód. 276-282**  
TRISSULPETZ SUSPENSÃO  
20ML E 50ML - NOXON



ORGANNACT



**Cód. 1983-1985**  
ORGANNACT PRATA  
200ML - 500ML -  
ORGANNACT



ORIENTE



**Cód. 1040**  
CEVADILHO 200G -  
ORIENTE



**Cód. 3278**  
COLEIRA ANTI-PULGA  
DUCAO 16G - ORIENTE



PINUS



**Cód. 3188**  
BIO AVES 50G - PINUS



**Cód. 2693**  
CARRAPATICIDA TOY  
CAES 100ML - PINUS



**Cód. 5092**  
TALCO ANTIPULGAS TOY  
PERF PINUS 100G - PINUS



PRADO



**Cód. 6401**  
DIPIRONA ORAL 25%  
PRADO 20ML - PRADO

**Provets®**  
Simões



SIMOES

**Cód. 3441**  
CANTOLINDO 100PS  
20ML - SIMOES



**Cód. 6229**  
CANTOLINDO  
ANTIBIOTICO 20ML -  
SIMOES

**Cód. 4337**  
CANTOLINDO  
ENERGETICO 30ML -  
SIMOES



**Cód. 4402**  
CANTOLINDO IODO  
30ML - SIMOES



**Cód. 4338**  
CANTOLINDO MAIS  
BELEZA 10ML - SIMOES



**Cód. 4339**  
CANTOLINDO MAIS  
FERTIL 10ML - SIMOES



**Cód. 4340**  
CANTOLINDO  
POLIVITAMINICO 30ML -  
SIMOES



**Cód. 4343**  
CANTOLINDO  
VERMIFUGO 15ML -  
SIMOES



**Cód. 4344**  
CANTOLINDO VIAS  
AEREAS 10ML - SIMOES



**Cód. 2531**  
COLIRIO CINERARIA  
MARITIMA 10ML - SIMOES



**Cód. 1071**  
SANAGOGO 20ML -  
SIMOES



**Cód. 270-1247-4900-5146**  
THUYA AVICOLA SIMOES  
20ML - 90ML - 150ML -  
500ML - SIMOES



**Cód. 4696**  
TOSSICANIS 90ML -  
SIMOES



SM



**Cód. 1292**  
ANTITOXICO SM ORAL  
20ML - SM



**Cód. 2034**  
CALCIOTRAT SM ORAL  
100ML - SM



**Cód. 2040**  
CORT-TRAT SM ORAL  
20CP - SM



**Cód. 898**  
ECTOMOSOL SOLUCAO  
30ML - SM



**Cód. 3041**  
ECTOMOSOL SPRAY  
120ML - SM





**Cód. 410**  
VETOCOC SM 4G - SM



SYNTEC



**Cód. 1535-3139-1534**  
DOXITEC 50MG - 100MG -  
200MG - SYNTEC



**Cód. 7463**  
MICODINE 2% 225ML -  
SYNTEC



UCB



**Cód. 1923**  
ANTICION 1,0ML - UCB



**Cód. 2052**  
ANTICION ENCARTELADO  
1 ML - UCB



**Cód. 2022**  
ANTITOXICO UCB ORAL  
20ML - UCB



**Cód. 10961**  
CHARMDOG  
CARRAPATICIDA PULV  
20ML - UCB



**Cód. 162**  
COLIRIO UCB 15ML - UCB



**Cód. 576**  
KARABÉ 30ML - UCB



**Cód. 902**  
NAUSETRAT SOLUCAO  
ORAL 20ML - UCB



**Cód. 6924**  
OTODEX30 ML - UCB



**Cód. 655**  
OTOLIN 15ML - UCB



**Cód. 603**  
SHAMPOO CHARMDOG  
INSET.AMARELO 250ML -  
UCB



**Cód. 148**  
TIMBACO SPRAY 100ML -  
UCB



VANSIL



**Cód. 3632**  
AVECOX 15ML - VANSIL



**Cód. 6847**  
V-CORT 0,5 MG 20CP -  
VANSIL



VETBRAS





**Cód. 6152-7488**  
AVERIN SOLUVEL 20 ML -  
100ML - VETBRAS



**Cód. 4949**  
AVERIN VETBRAS 1KG -  
VETBRAS



**Cód. 6427**  
BIOTRIN VET 100PS  
20ML - VETBRAS



**Cód. 2491**  
BIOTRIN VET ADE 20ML -  
VETBRAS



**Cód. 6426**  
BIOTRIN VET CALCIO +  
B12 20ML - VETBRAS



**Cód. 9119**  
BIOTRIN VET COMPLEXO  
VIT 20 ML - VETBRAS



**Cód. 2493**  
BIOTRIN VET FERRO  
20ML - VETBRAS



**Cód. 6423**  
BIOTRIN VET FERT.  
REPRODUÇÃO 20ML -  
VETBRAS



**Cód. 6421**  
BIOTRIN VET FILHOTES  
20ML - VETBRAS



**Cód. 6422**  
BIOTRIN VET MUDA DE  
PENAS 20ML - VETBRAS



**Cód. 6424**  
BIOTRIN VET PLUMAGEM  
20ML - VETBRAS



**Cód. 2501**  
BIOTRIN VET PO  
VITAMINADO 50G -  
VETBRAS



**Cód. 388**  
CALCIORAL B12 100ML -  
VETBRAS



**Cód. 2606**  
LINOVIT ADE 200ML -  
VETBRAS



**Cód. 6279**  
NATU VERM COMP PLUS  
660MG - VETBRAS



**Cód. 2893**  
NATU VERM PO 500GR -  
VETBRAS



**Cód. 785-3007-3487**  
NATU VIT 75ML - 240ML -  
500ML - VETBRAS



**Cód. 6520**  
PROBVET 14GR - VETBRAS



**Cód. 5858**  
PULGOL ANTIPULGAS  
100G - VETBRAS



**Cód. 6153**  
PULGOL ANTIPULGAS  
100G SACHE - VETBRAS



**Cód. 6151**  
**PULGOL ANTIPULGAS**  
**1KG - VETBRAS**



**Cód. 6232**  
**PULGOL SPRAY 120ML -**  
**VETBRAS**



**Cód. 5067**  
**TALCO PULGOL ANTIP**  
**TALQUEIRA 100G -**  
**VETBRAS**



**Cód. 1882**  
**VERMINEX GATOS**  
**4COMP - VETBRAS**



**Cód. 2982**  
**VERMIPLUS 20ML -**  
**VETBRAS**



**Cód. 2610-9779**  
**VET GOLD ORAL 20ML -**  
**50ML - VETBRAS**



**Cód. 4957**  
**VITA A VETBRAS 20ML -**  
**VETBRAS**



**Cód. 2613**  
**VITACANIS 250G -**  
**VETBRAS**



**WORLD**



**Cód. 76-3450**  
**DOXINEW 100MG 14CP -**  
**140CP - WORLD**

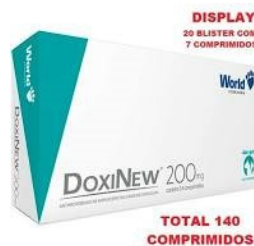

**Cód. 84-373**  
**DOXINEW 200MG 14CP -**  
**140CP - WORLD**



**Cód. 59-3472**  
**DOXINEW 50MG 14CP -**  
**140CP - WORLD**



**Cód. 1665-1664**  
**ENRONEW 50MG -**  
**150MG 10CP - WORLD**



**Cód. 1669-1671**  
**MELOXIWORLD 0,5MG -**  
**2,0MG 10CP - WORLD**



**Cód. 6453**  
**SHAMPOO DUGS**  
**CLOREXIDINA 500 ML -**  
**WORLD**



**Cód. 6503**  
**VERMICANIS PLUS 2,4 GR**  
**20CP - WORLD**



**Cód. 865**  
**VERMICANIS PLUS 30KG -**  
**WORLD**



**ZOETIS**



**Cód. 7271**  
**TERRAMICINA SOLUCAO**  
**20ML - ZOETIS**

CIRÚRGICA E  
DESCARTÁVEIS



CENTRAL  
VETERINÁRIA

CIRURGICA E  
DESCARTAVEIS



**Cód. 7233**  
AGULHA 30 X  
20\_FAZFORT - CIRURGICA  
E DESCARTAVEIS



**Cód. 7246**  
AGULHA  
30X18\_FAZFORTE -  
CIRURGICA E



**Cód. 2283**  
AGULHA DESC -  
CIRURGICA E  
DESCARTAVEIS



**Cód. 1313**  
AGULHA SUTURA EM S N  
11 - CIRURGICA E  
DESCARTAVEIS



**Cód. 6227**  
AGULHA SUTURA  
TRIANGULAR B04 -  
CIRURGICA E



**Cód. 7158**  
AGULHAS FAZFORTE-CX  
DIVERSASS - CIRURGICA E  
DESCARTAVEIS



**Cód. 9513**  
ALGODÃO - CIRURGICA E  
DESCARTAVEIS



**Cód. 226**  
APLICADOR SEMEM  
IMPORT. UNIVERSAL  
TRAVA - CIRURGICA E



**Cód. 4159**  
ATADURA CREPON  
CREMER - CIRURGICA E  
DESCARTAVEIS



**Cód. 4157**  
ATADURA CYSNE -  
CIRURGICA E  
DESCARTAVEIS



**Cód. 9530**  
ATADURA GESSADA -  
CIRURGICA E  
DESCARTAVEIS



**Cód. 9603**  
BOLSA DE SANGUE  
500ML - CIRURGICA E  
DESCARTAVEIS



**Cód. 5246**  
CABO FIXO BISTURI -  
CIRURGICA E  
DESCARTAVEIS



**Cód. 7212**  
CATEGUTE CROMADO -  
DIVERSOS - CIRURGICA E  
DESCARTAVEIS



**Cód. 7360**  
CATETER - CIRURGICA E  
DESCARTAVEIS



**Cód. 3660-3692**  
CUPINICIDA CIPER 25 SC  
100ML 1L - CIRURGICA E  
DESCARTAVEIS



**Cód. 6170**  
EQUIPO - CIRURGICA E  
DESCARTAVEIS



**Cód. 7208**  
ESPARADRAPO -  
CIRURGICA E  
DESCARTAVEIS



**Cód. 8037**  
GAZE - CIRURGICA E  
DESCARTAVEIS



**Cód. 2697**  
LAMINA BISTURI -  
CIRURGICA E  
DESCARTAVEIS





**Cód. 3599**  
LINHAS URSO CORRENTE -  
CIRURGICA E  
DESCARTAVEIS



**Cód. 6287**  
PINÇAS DIVERSAS -  
CIRURGICA E  
DESCARTAVEIS



**Cód. 7402**  
PORTA AGULHA MATHIEU  
20CM - CIRURGICA E  
DESCARTAVEIS

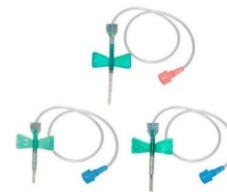

**Cód. 4809**  
SCALP - CIRURGICA E  
DESCARTAVEIS



**Cód. 1742**  
SERINGA VET 25ML -  
FAZFORT - CIRURGICA E  
DESCARTAVEIS



**Cód. 4537**  
SERINGA DESC -  
CIRURGICA E  
DESCARTAVEIS



**Cód. 1742**  
SERINGA VET ESPECIAL  
25ML AGULHA FAZFORT -  
CIRURGICA E



**Cód. 4722**  
SERINGAS  
DESCARTAVEIS -  
CIRURGICA E



**Cód. 2827**  
SONDA NASOESOFAGICA -  
CIRURGICA E  
DESCARTAVEIS



**Cód. 7498-7497**  
SORO FISIOLÓGICO 0,9%  
500ML - 1L - CIRURGICA E  
DESCARTAVEIS



**Cód. 7496-10062**  
SORO GLICOSE 5,0%  
500ML - 1L - CIRURGICA E  
DESCARTAVEIS



**Cód. 7501**  
SORO RINGER C FISIOL  
500ML - CIRURGICA E  
DESCARTAVEIS



**Cód. 7505-7504**  
SORO RINGER LACTATO  
500ML - 1L - CIRURGICA E  
DESCARTAVEIS



**Cód. 6039**  
TERMOMETRO  
VETERINARIO COM FIO -  
CIRURGICA E



**Cód. 7262**  
TESOURAS CIRURGICAS -  
DIVERSAS - CIRURGICA E  
DESCARTAVEIS



**Cód. 5920**  
TROCATER DIAM. 6MM  
COMP. 15CM - CIRURGICA  
E DESCARTAVEIS



**Cód. 6905-1047**  
TUBO FALCON 15ML -  
50ML - CIRURGICA E  
DESCARTAVEIS



**Cód. 725-6920-6921**  
TUBO VACUTAINER 4ML -  
9ML - 10ML - CIRURGICA  
E DESCARTAVEIS



CITROMAX\*



**Cód. 6974**  
AFASTA GATO 300GR -  
CITROMAX\*





**Cód. 4041**  
BARATICIDA GEL  
CITROMAX 10G -  
CITROMAX\*



**Cód. 2998**  
BARATICIDA PO 10 G -  
CITROMAX\*



**Cód. 6979**  
CITROMAX CITRONELA  
SPRAY 500 ML -  
CITROMAX\*



**Cód. 6908**  
CITROMAX FORMICIDA  
SPRAY 240 ML -  
CITROMAX\*



**Cód. 6906-6907-6909**  
CITROMAX SPRAY 50ML -  
100ML - 500ML -  
CITROMAX\*



**Cód. 6976-1944**  
CITROMAX SPRAY  
DOMESTICO 100ML - 500  
ML - CITROMAX\*



**Cód. 6991**  
CITROPIROL 200ML  
DESALOJANTE  
MORCEGOS - CITROMAX\*



**Cód. 3475**  
CUPINICIDA CIPER  
100ML - CITROMAX\*



**Cód. 6984**  
CUPINICIDA TOPMAX  
SPRAY 500ML -  
CITROMAX\*



**Cód. 3125**  
DDVP 500 CE  
INSET. TERMIMAS 1L -  
CITROMAX\*



**Cód. 4043**  
FORMICIDA GEL  
CITROMAX 10GR -  
CITROMAX\*



**Cód. 3664**  
FORMICIDA MADALDRIN  
400 500G FIPRONIL -  
CITROMAX\*



**Cód. 6470**  
FORMICIDA PO 40 TOP  
MAX 1,0 KG - CITROMAX\*



**Cód. 460**  
FORMIMAX  
DEDETIZACAO PLUS  
30ML - CITROMAX\*



**Cód. 4233-6320**  
FORMIMAX SPRAY 240  
ML - 500ML - CITROMAX\*



**Cód. 1341**  
GLIFOSATO CITROMAX  
1,0L - CITROMAX\*



**Cód. 1900**  
GLIFOSATO CITROMAX  
48% 100ML - CITROMAX\*



**Cód. 1893**  
IMAZAPIR GRAMIZAP  
PRONTO USO 1,0L -  
CITROMAX\*



**Cód. 6265-6983**  
IMAZAPIR GRAMIZAP  
SPRAY 500ML - 1L -  
CITROMAX\*



**Cód. 6973**  
INSETICIDA AEROSOL  
MULTI 300ML -  
CITROMAX\*



**Cód. 3697**  
INSETICIDA MAXTARION  
100ML - CITROMAX\*



**Cód. 3704**  
INSETICIDA MAXTARION  
150 GR - CITROMAX\*



**Cód. 3700**  
INSETICIDA TRITOMAX  
100 ML - CITROMAX\*



**Cód. 6910**  
ISCA FORMICIDA  
CITROMAX 300G  
FIPRONIL - CITROMAX\*



**Cód. 4652**  
ISCA FORMIMAX 500 G -  
CITROMAX\*



**Cód. 6982**  
LAMBDA TERMIMAX  
10PM 25G - CITROMAX\*



**Cód. 4917**  
LESMICIDA CITROMAX  
1KG - CITROMAX\*



**Cód. 6990**  
MADALDRIN SPRAY  
240ML - CITROMAX\*



**Cód. 7058**  
MOSQUICIDA COLA  
MOSCA CITROMAX  
50UN - CITROMAX\*



**Cód. 6986**  
MOSQUICIDA MOSKITRIN  
300GR - CITROMAX\*



**Cód. 3130**  
NUTRIPIROL 200 ML -  
CITROMAX\*



**Cód. 6985**  
ORIGINAL NEEM  
CITROMAX 200ML -  
CITROMAX\*



**Cód. 3702-3703**  
PULGALINE SPRAY 50 ML  
500ML - CITROMAX\*



**Cód. 4650**  
RALO LIMPO 70G -  
CITROMAX\*



**Cód. 3688-3691**  
RAT. CITROMAX ROSA  
BARRICA 3KG 8KG -  
CITROMAX\*



**Cód. 6978**  
RAT.ADESIVO CITROMAX  
12UN PEGA RATO -  
CITROMAX\*



**Cód. 6987**  
RAT.BLOCO TRIANGULAR  
CITROMAX 600G -  
CITROMAX\*



**Cód. 6988**  
RAT.CITROMAX ROSA  
1KG - CITROMAX\*



**Cód. 225**  
RAT.GIRASSOL CITROMAX  
25GR - CITROMAX\*



**Cód. 402**  
RAT.GIRASSOL CITROMAX  
BARRICA 5KG -  
CITROMAX\*



**Cód. 405**  
RAT.MIX CEREAIS CERAI  
BARRICA 5KG -  
CITROMAX\*



**Cód. 7003**  
RAT.MIX CEREAIS  
CITROMAX 25GR -  
CITROMAX\*



**Cód. 6165**  
RAT.PO CITROMAX 200G -  
CITROMAX\*



**Cód. 6975**  
SULFATO DE COBRE  
CALPIK 100ML -  
CITROMAX\*



**Cód. 6977**  
SULFATO DE COBRE  
CALPIK 1L - CITROMAX\*



**Cód. 1339**  
XO PASSARO GEL 250 G -  
CITROMAX\*



**Cód. 6981**  
XO PASSAROS 300GR -  
CITROMAX\*



DIPIL\*



**Cód. 6248**  
GLIFOSATO MADEMATO  
PLUS 1,0L - DIPIL\*



**Cód. 6101**  
ISCA FORM. GRAO VERDE  
FS 50G - DIPIL\*



**Cód. 2875**  
LAMBDA LAMTHRINE 10  
PM - DIPIL\*



**Cód. 7373**  
NEXXOR 30ML - DIPIL\*



**Cód. 6911**  
RAT.MADERAT GS  
PREMIUM 20GR - DIPIL\*



**Cód. 3555**  
RAT.MADERAT ROSA  
1KG - DIPIL\*



KELLDRIN\*



**Cód. 2231-8969**  
AGITHOR 100 GR -  
250GR - KELLDRIN\*



**Cód. 3938**  
BARATICIDA GEL  
BARAKELL 10G -  
KELLDRIN\*



**Cód. 4488**  
CUPINICIDA KELLTHINE SC  
25 400ML AEROS -  
KELLDRIN\*



**Cód. 5153-5152**  
CUPINICIDA ZODRIN 400  
CE 100ML - 1L - KELLDRIN\*



**Cód. 3937**  
CUPINICIDA ZODRIN PPU  
SPRAY 500ML - KELLDRIN\*





**Cód. 7382**  
DDVP 1000 CE 100 ML -  
KELLDRIN\*



**Cód. 5904**  
DESENGRIPANTE KELL-  
LUB 300 ML - KELLDRIN\*



**Cód. 3936**  
FORMICIDA GEL  
FORMIKELL 10G -  
KELLDRIN\*



**Cód. 4701**  
INSETICIDA KELLTHINE  
300ML SC AEROSOL -  
KELLDRIN\*



**Cód. 5158**  
INSETICIDA KELLTHINE  
SPRAY 500ML - KELLDRIN\*



**Cód. 5159-5157**  
INSETICIDA THORNADO  
TALQUEIRA 200G - 1KG -  
KELLDRIN\*



**Cód. 3935**  
ISCA FORM. ISCANILL  
500G - KELLDRIN\*



**Cód. 969**  
KELLBYOL 1KG -  
KELLDRIN\*



**Cód. 3934-2156**  
KELLBYOL PO DOMICILIAR  
TALQUEIRA 200G - 250G -  
KELLDRIN\*



**Cód. 3933**  
KELLDRIN SC 30ML -  
KELLDRIN\*



**Cód. 4489**  
KELLGRAN 1KG -  
KELLDRIN\*



**Cód. 3932-2638-4182**  
LESMICIDA KELLDRIN  
1KG - 1,25KG - 1,5KG -  
KELLDRIN\*



**Cód. 4181-4223**  
MALATHION KELLTHION  
500 CE 100ML - 1L -  
KELLDRIN\*



**Cód. 6892**  
MATA MOSCA MOSQ  
PODEROSO 30GR -  
KELLDRIN\*



**Cód. 6380-4572**  
MATT PULGAS BALDE  
1KG - 100G - KELLDRIN\*



**Cód. 7528-4968**  
MATT PULGOES 1KG  
(DISPLAY 100 X 10G) E  
(5X10G) - KELLDRIN\*



**Cód. 5310**  
MATT PULGOES PRONTO  
500ML - KELLDRIN\*



**Cód. 4364**  
MOSQUICIDA GEL  
PODEROSO 10G -  
KELLDRIN\*



**Cód. 8970**  
OLEO DE NEEM 80ML -  
KELLDRIN\*



**Cód. 4183-5911-5913**  
PODEROSO 25 CE 30ML -  
300ML - 1L - KELLDRIN\*



**Cód. 3929-4479**  
**PODEROSO PRONTO USO**  
150ML - 500ML -  
KELLDRIN\*



**Cód. 2965**  
**PODEROSO VET 30ML -**  
KELLDRIN\*



**Cód. 7530**  
**POTTENTE PO**  
HIDROSSOLUVEL 1KG -  
KELLDRIN\*



**Cód. 961**  
**PULVERIZADOR THE**  
GARDEN 1,5L - KELLDRIN\*



**Cód. 7005**  
**RAT.KELLMAT 1KG**  
(QUEIJO 40 X 25G) ROSA -  
KELLDRIN\*



**Cód. 4579**  
**RAT.KELLMAT ADESIVO -**  
KELLDRIN\*



**Cód. 4448-4451**  
**RAT.KELLMAT BLOCO**  
16G - 1KG - KELLDRIN\*



**Cód. 6895**  
**RAT.KELLMAT CEREAIS**  
GIRASSOL 25G -  
KELLDRIN\*



**Cód. 5058**  
**RAT.PO KELLMAT - PRO**  
1KG - KELLDRIN\*



**Cód. 4666**  
**RAT.PO KELLMAT 200G -**  
KELLDRIN\*



**Cód. 4909**  
**RATOEIRA PLASTICA**  
KELLMAT - KELLDRIN\*



**Cód. 8971**  
**SHAMPOO**  
COND.CLOREXIDINA  
500ML - KELLDRIN\*



**Cód. 6431**  
**SHAMPOO MATT PULGAS**  
6 EM 1 - 500ML -  
KELLDRIN\*



**KOMBATE\***



**Cód. 3202**  
**FORMICIDA SPARY**  
100ML - KOMBATE\*



**Cód. 3210**  
**INSETICIDA FORTHRINE**  
250 GR - KOMBATE\*



**Cód. 3257**  
**MATA PULGAS PULTRAT**  
4,5 KG - KOMBATE\*



**SERVER**



**Cód. 6508**  
**BARATICIDA GEL 7 BELO**  
10G - SERVER



**Cód. 6505**  
**FORMICIDA GEL 7 BELO**  
10G - SERVER



**Cód. 6504**  
**ISCA FORMICIDA 7 BELO F**  
**50G - SERVER**



**Cód. 6507**  
**MATA MOSCA**  
**MOSCAZUM 25G - SERVER**



**Cód. 1065**  
**RAT. RATUM GIRASSOL**  
**25GR - SERVER**



**Cód. 1061**  
**RAT. BLOCO RATUM**  
**20GR - SERVER**



**Cód. 1167-1164**  
**RAT. PO RATUM 1 KG (**  
**40X25GR) - PROF. 25G -**  
**SERVER**





- 01- Punho
- 02- Gatilho
- 03- Corpo
- 04- Vidro Temperado
- 05- Fundo
- 06- Bico Luer-Lock
- 07- Unha
- 08- Guia do Eixo Externo
- 09- Porca Guia nº8
- 10- Eixo Externo

- 11- Botão do Empurrador
- 12- Porca do Graduador
- 13- Parafuso da Unha
- 14- Parafuso do Gatilho
- 15- Eixo Interno
- 16- Mola do Gatilho Espiral
- 17- Mola do Graduador
- 18- Regulador de Dosagem
- 19- Parafuso de Dosagem

- 20- Placa de Dosagem
- 21- Encosto
- 22- Bucha
- 23- Parafuso da Placa nº20
- 25- Mola da Unha
- 26- Parafuso da Mola da Unha
- 27- Parafuso da Mola Gatilho
- 28- Regulador de Dosagem Completo

## Automática 50 ml – Reposição

- Cód. 101 – Punho
- Cód. 102 – Gatilho
- Cód. 103 – Corpo 50 ml
- Cód. 104 – Cilindro de Vidro 50 ml
- Cód. 105 – Fundo 50 ml
- Cód. 106 – Bico Luer Lock
- Cód. 107 – Unha
- Cód. 108 – Guia Eixo Externo
- Cód. 109 – Porca de Guia
- Cód. 110 – Eixo Externo 50 ml
- Cód. 111 – Botão Empurrador
- Cód. 112 – Porca do Graduador
- Cód. 113 – Parafuso de Unha
- Cód. 114 – Parafuso do Gatilho
- Cód. 115 – Eixo Interno 50 ml
- Cód. 116 – Molas Gatilho PAR
- Cód. 117 – Mola Graduador Espiral
- Cód. 118 – Regulador de Dosagem
- Cód. 119 – Parafuso de Dosagem
- Cód. 120 – Placa de Dosagem 50 ml
- Cód. 121 – Encosto
- Cód. 122 – Bucha
- Cód. 123 – Parafuso da Placa
- Cód. 124 – Conjunto de Reparo 50 ml
- Cód. 125 – Mola de Unha
- Cód. 126 – Parafusos da Mola Gatilho 16
- Cód. 127 – Parafuso da Mola Unha 25
- Cód. 128 – Regulador Dosagem Completo
- Cód. 046 - Mola de Unha Espiral
- Cód. 047 - Mola Gatilho Espiral

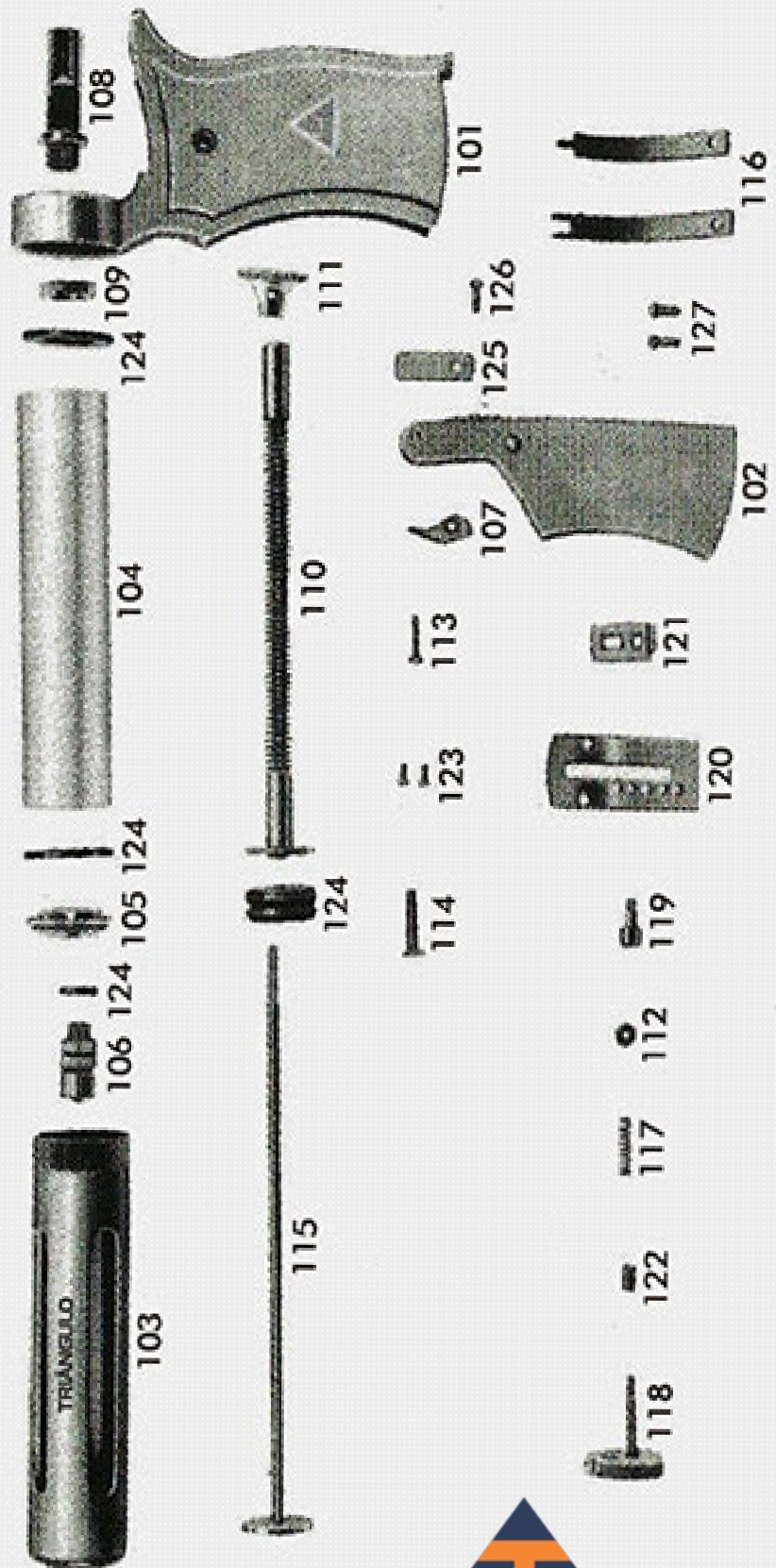

## Automática 30 ml - Reposição

- Corpo 30 ml
- Fundo 30 ml
- Placa Dosagem 30 ml
- Eixo Interno 30 ml
- Eixo Externo 30 ml
- Regulador Completo 30 ml
- Adaptador p/ Punho 30 ml



**CENTRAL**  
VETERINÁRIA

[CENTRALVETERINARIA.COM.BR](http://CENTRALVETERINARIA.COM.BR)





# ÍNDICE

BIASOLI	03	LEMA	10
BIMEDA	03	MATACURA	10
BIOFARM	03	MSD	11
BRAVET	04	NATURRICH	11
CALBOS	05	NOXON	12
CHEMITEC	05	ORGANNACT	12
CIRÚRG.E DESC	16	ORIENTE	12
CITROMAX	18	PINUS	12
COVELI	05	PRADO	12
DECHRA	06	SERVER	23
DIPIL	21	SIMÕES	13
FABIANI	07	SM	13
HIPRA	07	SYNTEC	14
IBASA	07	UCBVET	14
INDUBRAS	07	VANSIL	14
JOFADEL	08	VETBRÁS	14
KELLDRIN	21	VILAVET	03
KOMBATE	23	WORLD	16
LABGARD	08	ZOETIS	16
LAVIZOO	08		





VILAVET



Cód. 6882  
CEVIT 30ML - VILAVET



Cód. 8100  
HEMOVET PET 30ML -  
VILAVET



Cód. 8092  
SUPLENATE 250G -  
VILAVET



Cód. 8093  
VERMICOL 30ML - VILAVET



BIASOLI



Cód. 6024  
LEITE MAMALAC PET CAES  
E GATOS 250G - BIASOLI



BIMEDA



Cód. 2657  
PRAZIFEN CAES E GATOS -  
BIMEDA



BIOFARM



Cód. 644  
BABECID CAES 10ML -  
BIOFARM



Cód. 5102  
BIOTHION CAES 100 CP -  
BIOFARM



Cód. 5142  
BIOTOX PET PULV 20ML -  
BIOFARM



Cód. 4291  
BIOTRIL - BIOFARM



Cód. 2765  
CALCIOFARM MIX PET  
125ML - BIOFARM



Cód. 643  
CARBOVET 20 CP -  
BIOFARM



Cód. 4322  
CARRAPATOX PET - PULV.  
20ML - BIOFARM



Cód. 4274  
COLIRIO BIOFARM 20ML -  
BIOFARM



Cód. 642  
COLIRIO PET BIOFARM  
20ML - BIOFARM



Cód. 1390  
CORTISOL PET 20CP -  
BIOFARM



**Cód. 6885**  
DERMOTAN PET 100ML -  
BIOFARM



**Cód. 5228**  
ESTROGIN INJ 2ML -  
BIOFARM



**Cód. 5172-5173**  
FLOXICLIN 50MG - 150MG  
10CP - BIOFARM



**Cód. 4271**  
FLUIDO BIOFARM 100ML -  
BIOFARM



**Cód. 4294-4293-4296**  
GLICOFARM PET 30ML -  
60ML- 125ML - BIOFARM



**Cód. 4297-4298**  
HEMOfarm PET 30 - 60  
ML - BIOFARM



**Cód. 4308**  
HEPAVET INJ 10ML -  
BIOFARM



**Cód. 4410**  
IVERMECTINA  
BIOMECTINA DISPLAY  
50X1,0ML - BIOFARM



**Cód. 4266**  
LIDOFarm INJ 50ML -  
BIOFARM



**Cód. 5043**  
OTOVET LIMP 100ML -  
BIOFARM



**Cód. 5044**  
OTOVET SOLUCAO 20ML -  
BIOFARM



**Cód. 3327**  
SARNIRAN PET 30ML -  
BIOFARM



**Cód. 6443**  
SPOT PLUS 1,5 ML ATÉ  
10KG - BIOFARM



**Cód. 6445**  
SPOT PLUS 6,0 ML DE 20  
A 40KG - BIOFARM



**Cód. 1959**  
SPOT PLUS 9,0 ML ACIMA  
DE 40KG - BIOFARM



**Cód. 6444**  
SPOT PLUS 3,0 ML DE 10 A  
20KG - BIOFARM



**Cód. 1391**  
TUSSEDAN XAROPE  
100ML - BIOFARM



**Cód. 4312**  
VETIOLATE 30ML -  
BIOFARM



BRAVET



**Cód. 550**  
MERCEPTON ORAL 20ML -  
BRAVET





**Cód. 3471**  
**OTODERMIN 20ML - BRAVET**



**Cód. 4771**  
**SULFAPRIM 10CP - BRAVET**



**CALBOS**



**Cód. 6210**  
**ANTEC 4CP - CALBOS**



**CHEMITEC**



**Cód. 763**  
**CHEMITAL CAES 4CP - CHEMITEC**



**Cód. 953**  
**CHEMITAL GATOS 4CP - CHEMITEC**



**Cód. 762**  
**CHEMITAL PLUS 4CP - CHEMITEC**



**Cód. 1821**  
**CHEMITAL PUPPY ORAL 20ML - CHEMITEC**



**Cód. 3504**  
**CHEMITRIL 150MG 10CP - CHEMITEC**



**Cód. 3468**  
**CHEMITRIL 50MG 10CP - CHEMITEC**



**Cód. 3271**  
**DEXIUM 5MG - CHEMITEC**



**Cód. 4816**  
**EC-PET 1,34ML - CHEMITEC**



**Cód. 4817**  
**EC-PET 2,68ML - CHEMITEC**



**Cód. 4818**  
**EC-PET 4,02ML - CHEMITEC**



**Cód. 4815**  
**EC-PET 67ML - CHEMITEC**



**Cód. 7223**  
**ELO-XICAM 0,2% INJ. 20ML - CHEMITEC**



**Cód. 7221**  
**ELO-XICAM 0,5MG - CHEMITEC**



**Cód. 7222**  
**ELO-XICAM 2,0MG - CHEMITEC**



**COVELI - PET**



**Cód. 4497**  
**AVITRIN AMINOACIDOS**  
15ML - COVELI - PET



**Cód. 2453**  
**AVITRIN ANTIBIOTICO**  
10ML - COVELI - PET



**Cód. 2450**  
**AVITRIN CALCIO PLUS**  
15ML - COVELI - PET



**Cód. 2435**  
**AVITRIN E 15ML -**  
COVELI - PET



**Cód. 2452**  
**AVITRIN FERRO MAX 15**  
ML - COVELI - PET



**Cód. 2436**  
**AVITRIN MUDA 15 ML -**  
COVELI - PET



**Cód. 2448**  
**AVITRIN PLUMAS 15 ML -**  
COVELI - PET



**Cód. 2455**  
**AVITRIN POLIVITAMINICO**  
15 ML - COVELI - PET



**Cód. 4965**  
**AVITRIN PS 15 ML -**  
COVELI - PET



**Cód. 933**  
**AVITRIN REPRODUÇÃO 15**  
ML - COVELI - PET



**Cód. 2447**  
**AVITRIN SULFA 10ML -**  
COVELI - PET



**Cód. 2437**  
**AVITRIN VERMIFUGO 10**  
ML - COVELI - PET



**Cód. 2430**  
**COLEIRA VAPONEX 20GR -**  
COVELI - PET



**Cód. 2449**  
**TETISARNOL 150 ML**  
AEROSOL - COVELI - PET



DECHRA



**Cód. 4235**  
**ACEPROVEN GOTAS**  
30ML - DECHRA



**Cód. 3905**  
**SORO GASTROGLOBULIN**  
10ML - DECHRA



**Cód. 2612**  
**SORO GLOBULIN CANNIS**  
POLIVALENTE 5ML -  
DECHRA



**Cód. 4048**  
**SORO SOROGLOBULIN**  
10ML - DECHRA



**Cód. 6575**  
**SORO SOROGLOBULIN**  
MAX 10ML - DECHRA



**Cód. 3629**  
**VAC RAIVA BIORAIVA PET**  
**C/12 - DECHRA**



**FABIANI**



**Cód. 4431**  
**VITAGOLD ORAL**  
**POTENCIADO 20ML -**  
**FABIANI**



**HIPRA**



**Cód. 2919**  
**HIPRALONA ENRO S**  
**GOTAS 10ML - HIPRA**



*A vida exige o melhor.*

**IBASA**



**Cód. 1361**  
**CETOCONAZOL SHAMPOO**  
**2,0% 100ML - IBASA**



**Cód. 1368**  
**CETOCONAZOL**  
**SUSPENSÃO ORAL 20%**  
**20ML - IBASA**



**Cód. 1372**  
**IBATRIM ORAL CAES E**  
**GATOS 20ML - IBASA**



**Cód. 7606**  
**IBATRIM ORAL CAES E**  
**GATOS 50ML - IBASA**



**Cód. 7703**  
**OUVIPET**  
**DERMOCALMANTE IBASA**  
**30ML - IBASA**



**Cód. 1370**  
**SABONETE ANTIPULGAS**  
**IBAPET 80G - IBASA**



**Cód. 640**  
**SPRAY ANTIPULGAS E**  
**CARRAP IBASA 100ML -**  
**IBASA**



**Cód. 1371**  
**TALCO ANTIPULGAS**  
**IBASA 100G - IBASA**



**indubras**  
INDÚSTRIA VETERINÁRIA

**INDUBRAS**



**Cód. 6266**  
**AMITRAZ PET INDUBRAS**  
**20ML - INDUBRAS**



**Cód. 139-140**  
**AVEMIL SOLUÇÃO 20ML -**  
**100ML - INDUBRAS**

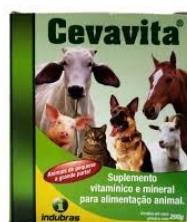

**Cód. 115**  
**CEVAVITA 200G -**  
**INDUBRAS**



**Cód. 6587**  
**FARINHA DE CALCIO**  
**INDUBRAS 1,0KG -**  
**INDUBRAS**



**Cód. 6268**  
**LINOPLUS 180ML -**  
**INDUBRAS**





**Cód. 1058**  
MATA BICHEIRA  
INDUBRAS PRATA  
200ML - INDUBRAS



**Cód. 3616**  
STRONDAL 4CP -  
INDUBRAS



**Cód. 1066**  
STRONDAL PLUS 4CP -  
INDUBRAS



**Cód. 143-144**  
THUYA TINTURA 20ML -  
90ML - INDUBRAS



**Cód. 3614**  
VERMEX PLUS ORAL  
20ML - INDUBRAS



**Cód. 3615**  
VERMEX SOLUCAO ORAL  
20ML - INDUBRAS



**Cód. 114**  
VERMITRAT P CAES-  
GATOS 150COMP -  
INDUBRAS



JOFADEL



**Cód. 3077**  
DOLEMIL BISNAGA 10G -  
JOFADEL



**Cód. 2033**  
PENAVIAR PO 30G -  
JOFADEL



LABGARD



**Cód. 7024**  
DEXAGARD 20CP -  
LABGARD



**Cód. 7388**  
ENROGARD 50MG -  
LABGARD



LAVIZOO



**Cód. 1990-1976**  
AMINOPAN PET 100G -  
500GR - LAVIZOO



**Cód. 4877**  
AMINOSOL PASSAROS  
10ML - LAVIZOO



**Cód. 1996**  
AMINOSOL PET 1,0L -  
LAVIZOO



**Cód. 2067**  
ANTI TARTARO LAVIZOO  
100GR - LAVIZOO



**Cód. 4936**  
AURICUR LIMP 100ML -  
LAVIZOO



**Cód. 1973-1974**  
FORTFLEX PET 30 COMP-  
60 COMP. - LAVIZOO



**Cód. 1414**  
GEL AURICULAR 11,5 GR  
VETANCO - LAVIZOO



**Cód. 2695**  
GELOVET GEL 300G -  
LAVIZOO



**Cód. 5356**  
GELOVET SPRAY 100ML -  
LAVIZOO



**Cód. 1979-1995**  
GLICOSOL PET 200ML - 50  
ML - LAVIZOO



**Cód. 867**  
HEPSEL PET 50GR -  
LAVIZOO



**Cód. 3301**  
LAVIZ MO PET 30GR -  
LAVIZOO



**Cód. 4860**  
LAVIZOO ANTIBIOTICO  
50GR LAVIMED SD -  
LAVIZOO



**Cód. 2865**  
LAVIZOO CALCIO 15ML -  
LAVIZOO



**Cód. 1969**  
LAVIZOO LIMPA  
LAGRIMAS 100ML -  
LAVIZOO



**Cód. 2866**  
LAVIZOO MUDA 15ML -  
LAVIZOO



**Cód. 2874**  
LAVIZOO  
REPRODUCAO/CANTO  
15ML - LAVIZOO



**Cód. 4888**  
OROSOL PASSAROS  
10ML - LAVIZOO



**Cód. 854**  
PROGARD F 5G - LAVIZOO



**Cód. 619**  
PROGARD PLUS 50 5G -  
LAVIZOO



**Cód. 2787-2694**  
SHAMPOO CETODINE  
125ML - 240ML - LAVIZOO



**Cód. 4357**  
SUPLECAL PET 200 GR -  
LAVIZOO



**Cód. 1975**  
SUPRAFER PET 30G -  
LAVIZOO



**Cód. 1795**  
SUPRAFER PET 50ML -  
LAVIZOO



**Cód. 4894**  
SUPRESSOR DE CIO 12CP -  
LAVIZOO



**Cód. 4806**  
VERMICAO 04CP -  
LAVIZOO



LEMA

**Cód. 3511**  
COLEIRA TRATTO 17G -  
LEMA

**Cód. 3025**  
INIBIDEX CARTELA 5  
UNID - LEMA

**Cód. 1921**  
INIBIDEX INJ 1ML - LEMA



**Cód. 2742**  
SABONETE SARNATYL  
100GR - LEMA

**Cód. 685**  
SORO CINO-GLOBULIN  
10ML GELADO AZUL -  
LEMA

**Cód. 684**  
SORO ENTERO-GLOBULIN  
10ML GELADO ROSA -  
LEMA

**Cód. 3152**  
TRIDOXIN 40 PASTA ORAL  
10ML - LEMA



**Cód. 6931**  
VAC BIO MAX BASICA (V8)  
2ML - LEMA

**Cód. 6935**  
VAC POLY 10 BASICA  
(V10) 2ML - LEMA

**Cód. 6937**  
VAC POLY 10 RASG APLIK  
(V10) 2ML - LEMA

**Cód. 6942**  
VAC RAIVA I CAES GATOS  
BASICA 1DS - LEMA



**Cód. 6938**  
VAC TRI BABY BASICA  
1,0ML - LEMA

**Cód. 3083**  
VERMOTRIX PLUS 04CP -  
LEMA

**Cód. 1586**  
VETOL INJ 2,0ML - LEMA

**Cód. 1587**  
VETOL SOLUCAO ORAL  
20ML - LEMA



MATACURA

**Cód. 694**  
POMADA CICATRIZANTE  
SARALOGO 30G -  
MATACURA

**Cód. 3268**  
SABONETE ANTISSEPTICO  
90G - MATACURA

**Cód. 3267**  
SABONETE SARNICIDA  
80G - MATACURA





**Cód. 2869**  
SHAMPOO ANTISSEPTICO  
HORSE 1,0L - MATACURA



**Cód. 3269**  
SHAMPOO SARNICIDA  
200ML - MATACURA



MSD



**Cód. 995**  
AZIUM SOLUCAO INJ  
10ML - MSD



**Cód. 4686**  
BANAMINE 10ML - MSD



**Cód. 1016**  
BIOXAN COMPOSTO  
500ML - MSD



**Cód. 283**  
BORGAL INJ 10ML - MSD



**Cód. 2079**  
BUTOX PULV. 20ML - MSD



**Cód. 1035**  
CALMINEX 30G - MSD



**Cód. 2402**  
DIAZEN INJ 15ML - MSD



**Cód. 1954**  
DORCIPEC INJ 10ML - MSD



**Cód. 3493**  
GLUCAFOS 200ML - MSD



**Cód. 2950**  
HEPATOXAN 100ML - MSD



**Cód. 1106**  
IMIZOL INJ 15ML - MSD



**Cód. 2575**  
POTENTY PULV. 300ML -  
MSD



**Cód. 6190**  
REVERIN PLUS LA 50ML -  
MSD



**Cód. 5445**  
SEPTIPEN PLUS 15ML  
DISPLAY - MSD



**Cód. 1253**  
TRIA TOX PULV 200ML -  
MSD



**Cód. 2748**  
ZALIX INJ 10ML - MSD



Naturrich

NATURRICH



**Cód. 2626**  
MEBENDAZOLE  
CAES/GATOS - NATURRICH



**Cód. 780**  
NATU VERM COMP CAES  
E GATOS - NATURRICH



**Cód. 429**  
NATU VERM SUSPENSÃO  
20ML - NATURRICH



**Cód. 786**  
NATUFLIN CX 10 COMP -  
NATURRICH



**Cód. 3030**  
PIPI NATU DOG 20ML -  
NATURRICH



**Cód. 778-783**  
THUYA AVICOLA  
NATURRICH 30ML -  
100ML - NATURRICH



NOXON



**Cód. 2980**  
PROBIOTICO PET NOXON  
14GR. - NOXON



**Cód. 276-282**  
TRISSULPETZ SUSPENSÃO  
20ML E 50ML - NOXON



ORGANNACT



**Cód. 1983-1985**  
ORGANNACT PRATA  
200ML - 500ML -  
ORGANNACT



ORIENTE



**Cód. 1040**  
CEVADILHO 200G -  
ORIENTE



**Cód. 3278**  
COLEIRA ANTI-PULGA  
DUCAO 16G - ORIENTE



PINUS



**Cód. 3188**  
BIO AVES 50G - PINUS



**Cód. 2693**  
CARRAPATICIDA TOY  
CAES 100ML - PINUS



**Cód. 5092**  
TALCO ANTIPULGAS TOY  
PERF PINUS 100G - PINUS



PRADO



**Cód. 6401**  
DIPIRONA ORAL 25%  
PRADO 20ML - PRADO

**Provets®**  
Simões



SIMOES

**Cód. 3441**  
CANTOLINDO 100PS  
20ML - SIMOES



**Cód. 6229**  
CANTOLINDO  
ANTIBIOTICO 20ML -  
SIMOES

**Cód. 4337**  
CANTOLINDO  
ENERGETICO 30ML -  
SIMOES



**Cód. 4402**  
CANTOLINDO IODO  
30ML - SIMOES



**Cód. 4338**  
CANTOLINDO MAIS  
BELEZA 10ML - SIMOES



**Cód. 4339**  
CANTOLINDO MAIS  
FERTIL 10ML - SIMOES



**Cód. 4340**  
CANTOLINDO  
POLIVITAMINICO 30ML -  
SIMOES



**Cód. 4343**  
CANTOLINDO  
VERMIFUGO 15ML -  
SIMOES



**Cód. 4344**  
CANTOLINDO VIAS  
AEREAS 10ML - SIMOES



**Cód. 2531**  
COLIRIO CINERARIA  
MARITIMA 10ML - SIMOES



**Cód. 1071**  
SANAGOGO 20ML -  
SIMOES



**Cód. 270-1247-4900-5146**  
THUYA AVICOLA SIMOES  
20ML - 90ML - 150ML -  
500ML - SIMOES



**Cód. 4696**  
TOSSICANIS 90ML -  
SIMOES



SM



**Cód. 1292**  
ANTITOXICO SM ORAL  
20ML - SM



**Cód. 2034**  
CALCIOTRAT SM ORAL  
100ML - SM



**Cód. 2040**  
CORT-TRAT SM ORAL  
20CP - SM



**Cód. 898**  
ECTOMOSOL SOLUCAO  
30ML - SM



**Cód. 3041**  
ECTOMOSOL SPRAY  
120ML - SM





**Cód. 410**  
VETOCOC SM 4G - SM



SYNTEC



**Cód. 1535-3139-1534**  
DOXITEC 50MG - 100MG -  
200MG - SYNTEC



**Cód. 7463**  
MICODINE 2% 225ML -  
SYNTEC



UCB



**Cód. 1923**  
ANTICION 1,0ML - UCB



**Cód. 2052**  
ANTICION ENCARTELADO  
1 ML - UCB



**Cód. 2022**  
ANTITOXICO UCB ORAL  
20ML - UCB



**Cód. 10961**  
CHARMDOG  
CARRAPATICIDA PULV  
20ML - UCB



**Cód. 162**  
COLIRIO UCB 15ML - UCB



**Cód. 576**  
KARABÉ 30ML - UCB



**Cód. 902**  
NAUSETRAT SOLUCAO  
ORAL 20ML - UCB



**Cód. 6924**  
OTODEX30 ML - UCB



**Cód. 655**  
OTOLIN 15ML - UCB



**Cód. 603**  
SHAMPOO CHARMDOG  
INSET.AMARELO 250ML -  
UCB



**Cód. 148**  
TIMBACO SPRAY 100ML -  
UCB



VANSIL



**Cód. 3632**  
AVECOX 15ML - VANSIL



**Cód. 6847**  
V-CORT 0,5 MG 20CP -  
VANSIL



VETBRAS



**Cód. 6152-7488**  
**AVERIN SOLUVEL 20 ML -**  
**100ML - VETBRAS**



**Cód. 4949**  
**AVERIN VETBRAS 1KG -**  
**VETBRAS**



**Cód. 6427**  
**BIOTRIN VET 100PS**  
**20ML - VETBRAS**



**Cód. 2491**  
**BIOTRIN VET ADE 20ML -**  
**VETBRAS**



**Cód. 6426**  
**BIOTRIN VET CALCIO +**  
**B12 20ML - VETBRAS**



**Cód. 9119**  
**BIOTRIN VET COMPLEXO**  
**VIT 20 ML - VETBRAS**



**Cód. 2493**  
**BIOTRIN VET FERRO**  
**20ML - VETBRAS**



**Cód. 6423**  
**BIOTRIN VET FERT.**  
**REPRODUÇÃO 20ML -**  
**VETBRAS**



**Cód. 6421**  
**BIOTRIN VET FILHOTES**  
**20ML - VETBRAS**



**Cód. 6422**  
**BIOTRIN VET MUDA DE**  
**PENAS 20ML - VETBRAS**



**Cód. 6424**  
**BIOTRIN VET PLUMAGEM**  
**20ML - VETBRAS**



**Cód. 2501**  
**BIOTRIN VET PO**  
**VITAMINADO 50G -**  
**VETBRAS**



**Cód. 388**  
**CALCIORAL B12 100ML -**  
**VETBRAS**



**Cód. 2606**  
**LINOVIT ADE 200ML -**  
**VETBRAS**



**Cód. 6279**  
**NATU VERM COMP PLUS**  
**660MG - VETBRAS**



**Cód. 2893**  
**NATU VERM PO 500GR -**  
**VETBRAS**



**Cód. 785-3007-3487**  
**NATU VIT 75ML - 240ML -**  
**500ML - VETBRAS**



**Cód. 6520**  
**PROBET 14GR - VETBRAS**



**Cód. 5858**  
**PULGOL ANTIPULGAS**  
**100G - VETBRAS**



**Cód. 6153**  
**PULGOL ANTIPULGAS**  
**100G SACHE - VETBRAS**



**Cód. 6151**  
**PULGOL ANTIPULGAS**  
**1KG - VETBRAS**



**Cód. 6232**  
**PULGOL SPRAY 120ML -**  
**VETBRAS**



**Cód. 5067**  
**TALCO PULGOL ANTIP**  
**TALQUEIRA 100G -**  
**VETBRAS**



**Cód. 1882**  
**VERMINEX GATOS**  
**4COMP - VETBRAS**



**Cód. 2982**  
**VERMIPLUS 20ML -**  
**VETBRAS**



**Cód. 2610-9779**  
**VET GOLD ORAL 20ML -**  
**50ML - VETBRAS**



**Cód. 4957**  
**VITA A VETBRAS 20ML -**  
**VETBRAS**



**Cód. 2613**  
**VITACANIS 250G -**  
**VETBRAS**



**WORLD**



**Cód. 76-3450**  
**DOXINEW 100MG 14CP -**  
**140CP - WORLD**

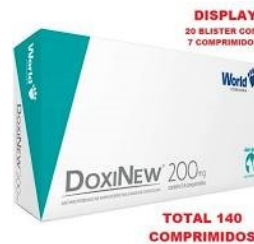

**Cód. 84-373**  
**DOXINEW 200MG 14CP -**  
**140CP - WORLD**



**Cód. 59-3472**  
**DOXINEW 50MG 14CP -**  
**140CP - WORLD**



**Cód. 1665-1664**  
**ENRONEW 50MG -**  
**150MG 10CP - WORLD**



**Cód. 1669-1671**  
**MELOXIWORLD 0,5MG -**  
**2,0MG 10CP - WORLD**



**Cód. 6453**  
**SHAMPOO DUGS**  
**CLOREXIDINA 500 ML -**  
**WORLD**



**Cód. 6503**  
**VERMICANIS PLUS 2,4 GR**  
**20CP - WORLD**



**Cód. 865**  
**VERMICANIS PLUS 30KG -**  
**WORLD**



**ZOETIS**



**Cód. 7271**  
**TERRAMICINA SOLUCAO**  
**20ML - ZOETIS**

CIRÚRGICA E  
DESCARTÁVEIS



CENTRAL  
VETERINÁRIA

CIRURGICA E  
DESCARTAVEIS





**Cód. 7233**  
AGULHA 30 X  
20\_FAZFORT - CIRURGICA  
E DESCARTAVEIS



**Cód. 7246**  
AGULHA  
30X18\_FAZFORTE -  
CIRURGICA E



**Cód. 2283**  
AGULHA DESC -  
CIRURGICA E  
DESCARTAVEIS



**Cód. 1313**  
AGULHA SUTURA EM S N  
11 - CIRURGICA E  
DESCARTAVEIS



**Cód. 6227**  
AGULHA SUTURA  
TRIANGULAR B04 -  
CIRURGICA E



**Cód. 7158**  
AGULHAS FAZFORTE-CX  
DIVERSASS - CIRURGICA E  
DESCARTAVEIS



**Cód. 9513**  
ALGODÃO - CIRURGICA E  
DESCARTAVEIS



**Cód. 226**  
APLICADOR SEMEM  
IMPORT. UNIVERSAL  
TRAVA - CIRURGICA E



**Cód. 4159**  
ATADURA CREPON  
CREMER - CIRURGICA E  
DESCARTAVEIS



**Cód. 4157**  
ATADURA CYSNE -  
CIRURGICA E  
DESCARTAVEIS



**Cód. 9530**  
ATADURA GESSADA -  
CIRURGICA E  
DESCARTAVEIS



**Cód. 9603**  
BOLSA DE SANGUE  
500ML - CIRURGICA E  
DESCARTAVEIS



**Cód. 5246**  
CABO FIXO BISTURI -  
CIRURGICA E  
DESCARTAVEIS



**Cód. 7212**  
CATEGUTE CROMADO -  
DIVERSOS - CIRURGICA E  
DESCARTAVEIS



**Cód. 7360**  
CATETER - CIRURGICA E  
DESCARTAVEIS



**Cód. 3660-3692**  
CUPINICIDA CIPER 25 SC  
100ML 1L - CIRURGICA E  
DESCARTAVEIS



**Cód. 6170**  
EQUIPO - CIRURGICA E  
DESCARTAVEIS



**Cód. 7208**  
ESPARADRAPO -  
CIRURGICA E  
DESCARTAVEIS



**Cód. 8037**  
GAZE - CIRURGICA E  
DESCARTAVEIS



**Cód. 2697**  
LAMINA BISTURI -  
CIRURGICA E  
DESCARTAVEIS



**Cód. 3599**  
LINHAS URSO CORRENTE -  
CIRURGICA E  
DESCARTAVEIS



**Cód. 6287**  
PINÇAS DIVERSAS -  
CIRURGICA E  
DESCARTAVEIS



**Cód. 7402**  
PORTA AGULHA MATHIEU  
20CM - CIRURGICA E  
DESCARTAVEIS

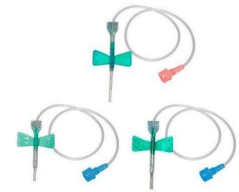

**Cód. 4809**  
SCALP - CIRURGICA E  
DESCARTAVEIS



**Cód. 1742**  
SERINGA VET 25ML -  
FAZFORT - CIRURGICA E  
DESCARTAVEIS



**Cód. 4537**  
SERINGA DESC -  
CIRURGICA E  
DESCARTAVEIS



**Cód. 1742**  
SERINGA VET ESPECIAL  
25ML AGULHA FAZFORT -  
CIRURGICA E



**Cód. 4722**  
SERINGAS  
DESCARTAVEIS -  
CIRURGICA E



**Cód. 2827**  
SONDA NASOESOFAGICA -  
CIRURGICA E  
DESCARTAVEIS



**Cód. 7498-7497**  
SORO FISIOLÓGICO 0,9%  
500ML - 1L - CIRURGICA E  
DESCARTAVEIS



**Cód. 7496-10062**  
SORO GLICOSE 5,0%  
500ML - 1L - CIRURGICA E  
DESCARTAVEIS



**Cód. 7501**  
SORO RINGER C FISIOL  
500ML - CIRURGICA E  
DESCARTAVEIS



**Cód. 7505-7504**  
SORO RINGER LACTATO  
500ML - 1L - CIRURGICA E  
DESCARTAVEIS



**Cód. 6039**  
TERMOMETRO  
VETERINARIO COM FIO -  
CIRURGICA E



**Cód. 7262**  
TESOURAS CIRURGICAS -  
DIVERSAS - CIRURGICA E  
DESCARTAVEIS



**Cód. 5920**  
TROCATER DIAM. 6MM  
COMP. 15CM - CIRURGICA  
E DESCARTAVEIS



**Cód. 6905-1047**  
TUBO FALCON 15ML -  
50ML - CIRURGICA E  
DESCARTAVEIS



**Cód. 725-6920-6921**  
TUBO VACUTAINER 4ML -  
9ML - 10ML - CIRURGICA  
E DESCARTAVEIS



CITROMAX\*



**Cód. 6974**  
AFASTA GATO 300GR -  
CITROMAX\*



**Cód. 4041**  
BARATICIDA GEL  
CITROMAX 10G -  
CITROMAX\*



**Cód. 2998**  
BARATICIDA PO 10 G -  
CITROMAX\*



**Cód. 6979**  
CITROMAX CITRONELA  
SPRAY 500 ML -  
CITROMAX\*



**Cód. 6908**  
CITROMAX FORMICIDA  
SPRAY 240 ML -  
CITROMAX\*



**Cód. 6906-6907-6909**  
CITROMAX SPRAY 50ML -  
100ML - 500ML -  
CITROMAX\*



**Cód. 6976-1944**  
CITROMAX SPRAY  
DOMESTICO 100ML - 500  
ML - CITROMAX\*



**Cód. 6991**  
CITROPIROL 200ML  
DESALOJANTE  
MORCEGOS - CITROMAX\*



**Cód. 3475**  
CUPINICIDA CIPER  
100ML - CITROMAX\*



**Cód. 6984**  
CUPINICIDA TOPMAX  
SPRAY 500ML -  
CITROMAX\*



**Cód. 3125**  
DDVP 500 CE  
INSET. TERMIMAS 1L -  
CITROMAX\*



**Cód. 4043**  
FORMICIDA GEL  
CITROMAX 10GR -  
CITROMAX\*



**Cód. 3664**  
FORMICIDA MADALDRIN  
400 500G FIPRONIL -  
CITROMAX\*



**Cód. 6470**  
FORMICIDA PO 40 TOP  
MAX 1,0 KG - CITROMAX\*



**Cód. 460**  
FORMIMAX  
DEDETIZACAO PLUS  
30ML - CITROMAX\*



**Cód. 4233-6320**  
FORMIMAX SPRAY 240  
ML - 500ML - CITROMAX\*



**Cód. 1341**  
GLIFOSATO CITROMAX  
1,0L - CITROMAX\*



**Cód. 1900**  
GLIFOSATO CITROMAX  
48% 100ML - CITROMAX\*



**Cód. 1893**  
IMAZAPIR GRAMIZAP  
PRONTO USO 1,0L -  
CITROMAX\*



**Cód. 6265-6983**  
IMAZAPIR GRAMIZAP  
SPRAY 500ML - 1L -  
CITROMAX\*



**Cód. 6973**  
INSETICIDA AEROSOL  
MULTI 300ML -  
CITROMAX\*





**Cód. 3697**  
INSETICIDA MAXTARION  
100ML - CITROMAX\*



**Cód. 3704**  
INSETICIDA MAXTARION  
150 GR - CITROMAX\*



**Cód. 3700**  
INSETICIDA TRITOMAX  
100 ML - CITROMAX\*



**Cód. 6910**  
ISCA FORMICIDA  
CITROMAX 300G  
FIPRONIL - CITROMAX\*



**Cód. 4652**  
ISCA FORMIMAX 500 G -  
CITROMAX\*



**Cód. 6982**  
LAMBDA TERMIMAX  
10PM 25G - CITROMAX\*



**Cód. 4917**  
LESMICIDA CITROMAX  
1KG - CITROMAX\*



**Cód. 6990**  
MADALDRIN SPRAY  
240ML - CITROMAX\*



**Cód. 7058**  
MOSQUICIDA COLA  
MOSCA CITROMAX  
50UN - CITROMAX\*



**Cód. 6986**  
MOSQUICIDA MOSKITRIN  
300GR - CITROMAX\*



**Cód. 3130**  
NUTRIPIROL 200 ML -  
CITROMAX\*



**Cód. 6985**  
ORIGINAL NEEM  
CITROMAX 200ML -  
CITROMAX\*



**Cód. 3702-3703**  
PULGALINE SPRAY 50 ML  
500ML - CITROMAX\*



**Cód. 4650**  
RALO LIMPO 70G -  
CITROMAX\*



**Cód. 3688-3691**  
RAT. CITROMAX ROSA  
BARRICA 3KG 8KG -  
CITROMAX\*



**Cód. 6978**  
RAT.ADESIVO CITROMAX  
12UN PEGA RATO -  
CITROMAX\*



**Cód. 6987**  
RAT.BLOCO TRIANGULAR  
CITROMAX 600G -  
CITROMAX\*



**Cód. 6988**  
RAT.CITROMAX ROSA  
1KG - CITROMAX\*



**Cód. 225**  
RAT.GIRASSOL CITROMAX  
25GR - CITROMAX\*



**Cód. 402**  
RAT.GIRASSOL CITROMAX  
BARRICA 5KG -  
CITROMAX\*



**Cód. 405**  
RAT.MIX CEREAIS CERAI  
BARRICA 5KG -  
CITROMAX\*



**Cód. 7003**  
RAT.MIX CEREAIS  
CITROMAX 25GR -  
CITROMAX\*



**Cód. 6165**  
RAT.PO CITROMAX 200G -  
CITROMAX\*



**Cód. 6975**  
SULFATO DE COBRE  
CALPIK 100ML -  
CITROMAX\*



**Cód. 6977**  
SULFATO DE COBRE  
CALPIK 1L - CITROMAX\*



**Cód. 1339**  
XO PASSARO GEL 250 G -  
CITROMAX\*



**Cód. 6981**  
XO PASSAROS 300GR -  
CITROMAX\*



DIPIL\*



**Cód. 6248**  
GLIFOSATO MADEMATO  
PLUS 1,0L - DIPIL\*



**Cód. 6101**  
ISCA FORM. GRAO VERDE  
FS 50G - DIPIL\*



**Cód. 2875**  
LAMBDA LAMTHRINE 10  
PM - DIPIL\*



**Cód. 7373**  
NEXXOR 30ML - DIPIL\*



**Cód. 6911**  
RAT.MADERAT GS  
PREMIUM 20GR - DIPIL\*



**Cód. 3555**  
RAT.MADERAT ROSA  
1KG - DIPIL\*



KELLDRIIN\*



**Cód. 2231-8969**  
AGITHOR 100 GR -  
250GR - KELLDRIIN\*



**Cód. 3938**  
BARATICA GEL  
BARAKELL 10G -  
KELLDRIIN\*



**Cód. 4488**  
CUPINICIDA KELLTHINE SC  
25 400ML AEROS -  
KELLDRIIN\*



**Cód. 5153-5152**  
CUPINICIDA ZODRIN 400  
CE 100ML - 1L - KELLDRIIN\*



**Cód. 3937**  
CUPINICIDA ZODRIN PPU  
SPRAY 500ML - KELLDRIIN\*



**Cód. 7382**  
DDVP 1000 CE 100 ML -  
KELLDRIN\*



**Cód. 5904**  
DESENGRIPANTE KELL-  
LUB 300 ML - KELLDRIN\*



**Cód. 3936**  
FORMICIDA GEL  
FORMIKELL 10G -  
KELLDRIN\*



**Cód. 4701**  
INSETICIDA KELLTHINE  
300ML SC AEROSOL -  
KELLDRIN\*



**Cód. 5158**  
INSETICIDA KELLTHINE  
SPRAY 500ML - KELLDRIN\*



**Cód. 5159-5157**  
INSETICIDA THORNADO  
TALQUEIRA 200G - 1KG -  
KELLDRIN\*



**Cód. 3935**  
ISCA FORM. ISCANILL  
500G - KELLDRIN\*



**Cód. 969**  
KELLBYOL 1KG -  
KELLDRIN\*



**Cód. 3934-2156**  
KELLBYOL PO DOMICILIAR  
TALQUEIRA 200G - 250G -  
KELLDRIN\*



**Cód. 3933**  
KELLDRIN SC 30ML -  
KELLDRIN\*



**Cód. 4489**  
KELLGRAN 1KG -  
KELLDRIN\*



**Cód. 3932-2638-4182**  
LESMICIDA KELLDRIN  
1KG - 1,25KG - 1,5KG -  
KELLDRIN\*



**Cód. 4181-4223**  
MALATHION KELLTHION  
500 CE 100ML - 1L -  
KELLDRIN\*



**Cód. 6892**  
MATA MOSCA MOSQ  
PODEROSO 30GR -  
KELLDRIN\*



**Cód. 6380-4572**  
MATT PULGAS BALDE  
1KG - 100G - KELLDRIN\*



**Cód. 7528-4968**  
MATT PULGOES 1KG  
(DISPLAY 100 X 10G) E  
(5X10G) - KELLDRIN\*



**Cód. 5310**  
MATT PULGOES PRONTO  
500ML - KELLDRIN\*



**Cód. 4364**  
MOSQUICIDA GEL  
PODEROSO 10G -  
KELLDRIN\*



**Cód. 8970**  
OLEO DE NEEM 80ML -  
KELLDRIN\*



**Cód. 4183-5911-5913**  
PODEROSO 25 CE 30ML -  
300ML - 1L - KELLDRIN\*





**Cód. 3929-4479**  
**PODEROSO PRONTO USO**  
150ML - 500ML -  
KELLDRIN\*



**Cód. 2965**  
**PODEROSO VET 30ML -**  
KELLDRIN\*



**Cód. 7530**  
**POTTENTE PO**  
HIDROSSOLUVEL 1KG -  
KELLDRIN\*



**Cód. 961**  
**PULVERIZADOR THE**  
GARDEN 1,5L - KELLDRIN\*



**Cód. 7005**  
**RAT.KELLMAT 1KG**  
(QUEIJO 40 X 25G) ROSA -  
KELLDRIN\*



**Cód. 4579**  
**RAT.KELLMAT ADESIVO -**  
KELLDRIN\*



**Cód. 4448-4451**  
**RAT.KELLMAT BLOCO**  
16G - 1KG - KELLDRIN\*



**Cód. 6895**  
**RAT.KELLMAT CEREAIS**  
GIRASSOL 25G -  
KELLDRIN\*



**Cód. 5058**  
**RAT.PO KELLMAT - PRO**  
1KG - KELLDRIN\*



**Cód. 4666**  
**RAT.PO KELLMAT 200G -**  
KELLDRIN\*



**Cód. 4909**  
**RATOEIRA PLASTICA**  
KELLMAT - KELLDRIN\*



**Cód. 8971**  
**SHAMPOO**  
COND.CLOREXIDINA  
500ML - KELLDRIN\*



**Cód. 6431**  
**SHAMPOO MATT PULGAS**  
6 EM 1 - 500ML -  
KELLDRIN\*



KOMBATE\*



**Cód. 3202**  
**FORMICIDA SPARY**  
100ML - KOMBATE\*



**Cód. 3210**  
**INSETICIDA FORTHRINE**  
250 GR - KOMBATE\*



**Cód. 3257**  
**MATA PULGAS PULTRAT**  
4,5 KG - KOMBATE\*



SERVER



**Cód. 6508**  
**BARATICIDA GEL 7 BELO**  
10G - SERVER



**Cód. 6505**  
**FORMICIDA GEL 7 BELO**  
10G - SERVER



**Cód. 6504**  
**ISCA FORMICIDA 7 BELO F**  
**50G - SERVER**



**Cód. 6507**  
**MATA MOSCA**  
**MOSCAZUM 25G - SERVER**



**Cód. 1065**  
**RAT. RATUM GIRASSOL**  
**25GR - SERVER**



**Cód. 1061**  
**RAT. BLOCO RATUM**  
**20GR - SERVER**



**Cód. 1167-1164**  
**RAT. PO RATUM 1 KG (**  
**40X25GR) - PROF. 25G -**  
**SERVER**